

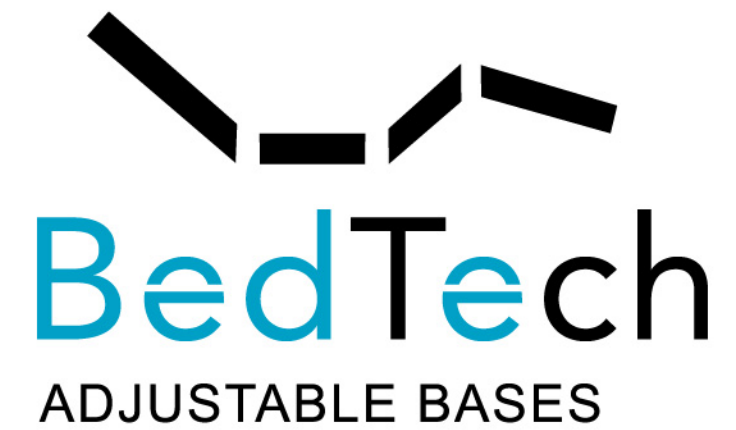

Customer Service: 1-888-236-3044



OWNER'S MANUAL

Installation & Operation



Serial No.

Safety & Warranty Warnings	01
Parts List	02
BT2000LP Electronics Quick Reference Guide	03
BT2500LP Electronics Quick Reference Guide	05
BT3000LP Electronics Quick Reference Guide	06
BT3500 Electronics Quick Reference Guide	07
Installation Guide	08
BT2000LP/BT2500LP Remote Control Instructions.....	09
BT3000LP Remote Control Instructions.....	10
BT3500LP Remote Control Instructions.....	11
BT3000 Remote Control Instructions (i- Control for TXL, Split Queen, Split Cal King)	12
i Control function Guide.....	13
All models Bluetooth Instructions.....	14
Setting Programmable Positions and Pairing Remote.....	16
Synchronizing Two Bases.....	17
Headboard Bracket Installation Guide	18
Troubleshooting	19

READ THE FOLLOWING INFORMATION CAREFULLY BEFORE USING THIS PRODUCT

If unable to understand warnings, cautions, and/or instructions, contact the dealer or technical personnel if applicable, before attempting to use the equipment. Otherwise, injury or damage may result.

SAFETY WARNINGS:

- Do not use bed outdoors.
- Do not use bed near explosives.
- Using bed with oxygen administering equipment other than the nasal masked type creates a possible fire hazard.
- When using nasal or masked type administering equipment, route and secure oxygen or air tubing properly to ensure that tubing does not become entangled or damaged during normal operation of the bed.
- Use caution when having liquids in or around the bed to ensure no spilling occurs. In case of spillage, stand in a dry, clean area of the floor and unplug the bed immediately. Clean up spill and allow the area around bed to dry thoroughly before using the electric controls again. Do not eat or drink hot liquids while operating the bed.
- This appliance is not intended for use by persons (including children) with reduced physical, sensory or mental capabilities, or lack of experience and knowledge, unless they have been given supervision or instructions concerning use of the appliance by a person responsible for their safety.
- Do not allow children or individuals with disabilities to operate the bed without adult supervision.
- Do not allow any person or pet under the bed at any time.
- During bed operation, make sure body is positioned within the confines of the bed. Do not place extremities over the sides of the bed when operating bed functions.

WARRANTY WARNINGS:

Do not open or tamper with control box, motors, or remote (with the exception of battery compartments). The warranty will be void if the internal workings of these components are tampered with.

Product Rating:

The motors are not designed to operate continuously for more than [2] minutes in an [18] minute time period or approximately 10% duty cycle. Attempting to circumvent or exceed this rating will shorten the life expectancy of the foundation and may void the warranty.

Operating Information:

- After power foundation assembly is completed, operate remote control to ensure proper functions.
- Keep moving parts free of obstruction during bed operation (including sheets, clothing, tubing, wiring, and products using electric power cords).
- Distribute body weight evenly over bed surface. Do not place entire weight on head or foot sections of the bed, during repositioning and entering or exiting bed.

Hospital Use Disclaimer:

This power foundation is designed for residential use only. It is not approved for hospital use and does not comply with hospital standards.

Weight Limits:

This product is not rated to support weights in excess of 850 pounds inclusive of the mattress and bedding. The bed will structurally support this weight, provided it is evenly distributed across the foundation. The power foundation is not designed to support or lift this amount in the head or foot sections alone. Exceeding this weight restriction could damage the bed and/or cause injury and will void the warranty.



RADIO FREQUENCY: 2.4 GHz

FCC COMPLIANCE:

This device complies with Part 15 of the FCC Rules. Operation is subject to the following two conditions: (1) This device may not cause harmful interference, and (2) this device must accept any interference received, including interference that may cause undesired operation.

To comply with the FCC RF exposure requirements, no change to the antenna or the device is permitted. Any change to the antenna or the device could result in the device exceeding the RF exposure requirement and void user's right to operate the device.

BED-TECH WARRANTY ADJUSTABLE BASES

In the warranty: "Adjustable base" means the adjustable bed foundation sold by Bed-Tech to an authorized dealer. The "adjustable base" does not include the mattress. "Purchaser" and "You" both mean the consumer who is the original purchaser of this adjustable base produced by Bed-Tech. This warranty is not transferable. "Warranty Commencement Date" means the date You purchased a new and unused Bed-Tech adjustable base. Bed-Tech warrants this adjustable base to You on the terms and over the reducing periods of time set out below. All warranty claims require notice from You to be given to Bed-Tech in the manner set out below, and to be received by Bed-Tech inside the applicable warranty time period.

1ST & 2ND YEAR FULL WARRANTY

For the 1st and 2nd year from the Warranty Commencement Date, your adjustable base is warranted against non-excluded defects in Bed-Tech's workmanship or materials. During the 1st and 2nd year from the Warranty Commencement Date, Bed-Tech will repair or replace (at no cost to You) any defective adjustable base part, and Bed-Tech will pay all authorized labor associated with the repair or replacement of any parts found to be defective. In the case where adjustable base needs to be replaced, Bed-Tech does not cover or pay for any part of transportation costs.

3RD THROUGH 15TH YEAR LIMITED WARRANTY

During the 3rd through end of the 15th year from the Warranty Commencement Date, Bed-Tech will cover a 50% prorated portion of any electronic part not excluded by this warranty. You are responsible to pay all service costs related to receiving and installing the new part. Electronics covered include: motor, control box, power supply, remote control, control box, massage motor, LED light, and USB charging port. Bed-Tech will pay for and cover the cost of shipping parts to the lower 48 states only. Customer will be responsible to pay 50% of the parts cost that the prorated warranty does not cover. For example, if you make a claim for an eligible motor and the part costs \$129 you would be responsible to pay \$64.50.

3RD YEAR TO 20TH YEAR LIMITED WARRANTY

Starting in the 3rd year from the Warranty Commencement Date and through to the end of the 20th year from the Warranty Commencement Date, Bed-Tech will provide any steel base parts found to be defective and not excluded by this warranty. This warranty only covers the steel mechanism frame. Bed-Tech will provide at no cost to You the metal parts for the defective frame. You are responsible to pay all service and transportation costs related to receiving and installing the new part. In the case of a defective steel base, if shipping costs and labor costs are excessive, customer may choose a 50% prorated warranty and receive a new same or comparable model for 50% of customer's purchase price. Customer is responsible for all and any shipping costs associated with this warranty.

ADDITIONAL TERMS AND CONDITIONS EXCLUSIONS:

This warranty does not apply; (a) to any damage caused by You; (b) if there has been any repair or replacement of adjustable base parts by an unauthorized person; (c) if the adjustable base has been mishandled (whether in transit or by other means), subjected to physical or electrical abuse or misuse, or otherwise operated in any manner inconsistent with the operation and maintenance procedures outlined in the Owner's Manual and this warranty; (d) to damage to mattresses, fabric, cables, electrical cords or items supplied by dealers (contact the dealer for warranty information on these items); (e) if there has been any modification of the adjustable base without prior written consent by Bed-Tech; or (f) to costs for unnecessary service calls, including costs for in-home service calls solely for the purpose of educating You about the adjustable base or finding a satisfactory power connection.

This warranty will be void if either the recommended weight restriction is not followed which is 850 total lbs. including persons, mattresses, and bedding materials, for non-manufactured defects, or if any modifications are made to the adjustable base.

This warranty will only apply to the original purchaser and will be void to a subsequent owner.

Any repairs to or replacement to Your adjustable base or its components under the terms of this limited warranty does not extend the applicable warranty from the Warranty Commencement Date. This time limitation may not apply in some jurisdictions, including the Province of Quebec. The decision to repair or to replace defective parts under this warranty shall be made, or cause to be made, by Bed-Tech at its option and in its sole discretion.

There shall be no liability on the part of Bed-Tech for any special, indirect, incidental, or consequential damages or for any other damage, claim, or loss not expressly covered by the terms of this warranty.

This limited warranty does not include reimbursement for inconvenience, removal, installation, setup time, loss of use, shipping, or any other costs or expenses. Bed-Tech and its service technicians will not be responsible for moving furniture or any other items not attached to the adjustable base in order to perform service on the adjustable base.

It is the sole responsibility of You to provide adequate space and accessibility to the adjustable base. In the event that the technician is unable to perform service due to lack of accessibility, the service call will be billed to You and the service will have to be rescheduled.

Bed-Tech makes no other warranty whatsoever, express or implied, and all implied warranties of merchantability and fitness for a particular purpose are disclaimed by Bed-Tech and excluded from this agreement.

Some American States do not allow the exclusion or limitation of incidental or consequential damages, so the above limitation or exclusion may not apply to You. This warranty gives You specific legal rights, and You may also have other rights, which may vary from jurisdiction to jurisdiction. This warranty is valid in all 50 American states and the District of Columbia.

For customer service under this limited warranty please contact Bed-Tech by phone, mail, or email.

BED-TECH
4707 W. VAN BUREN ST
PHOENIX, AZ 85043

For service year 1-2 toll free phone: 1.888.236.3044
For parts and service year 3-20: 602.442.6609
online: support@bedtech.com

All electronics and components that need to be installed are located in boxes under the foundation or attached to the frame. Before discarding the packing materials, ensure that all the parts are accounted for.

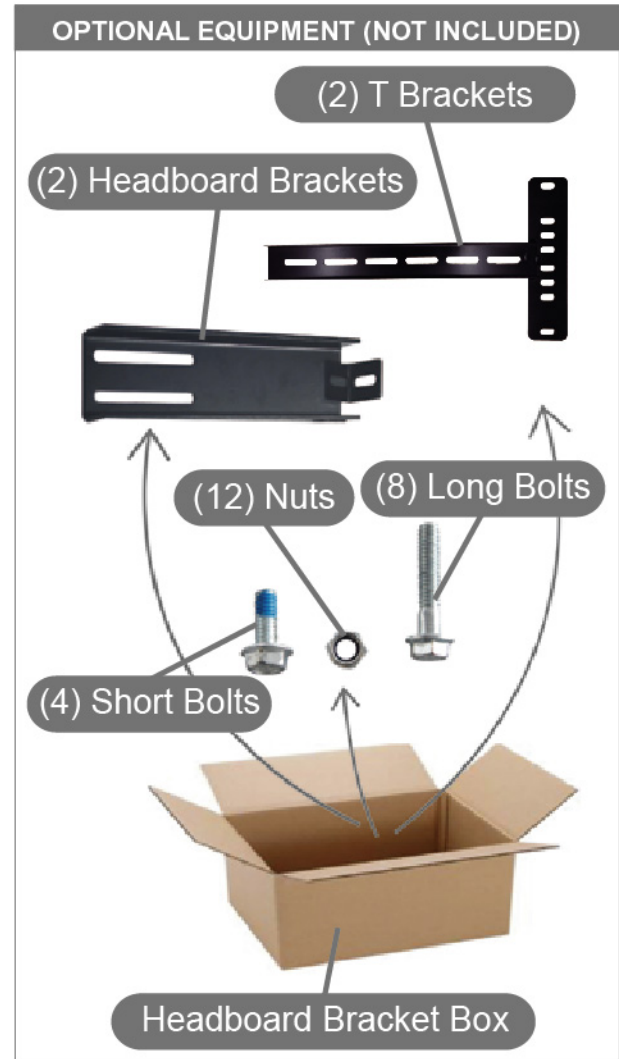

OPTIONAL EQUIPMENT (NOT INCLUDED)

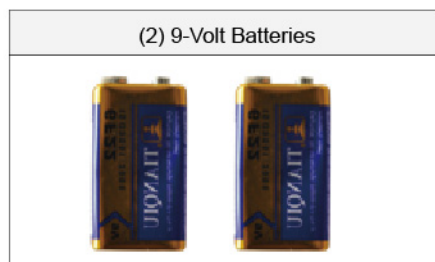

Actual product appearance and functionality may vary from photographs.

BT2000LP WIRELESS OVERVIEW

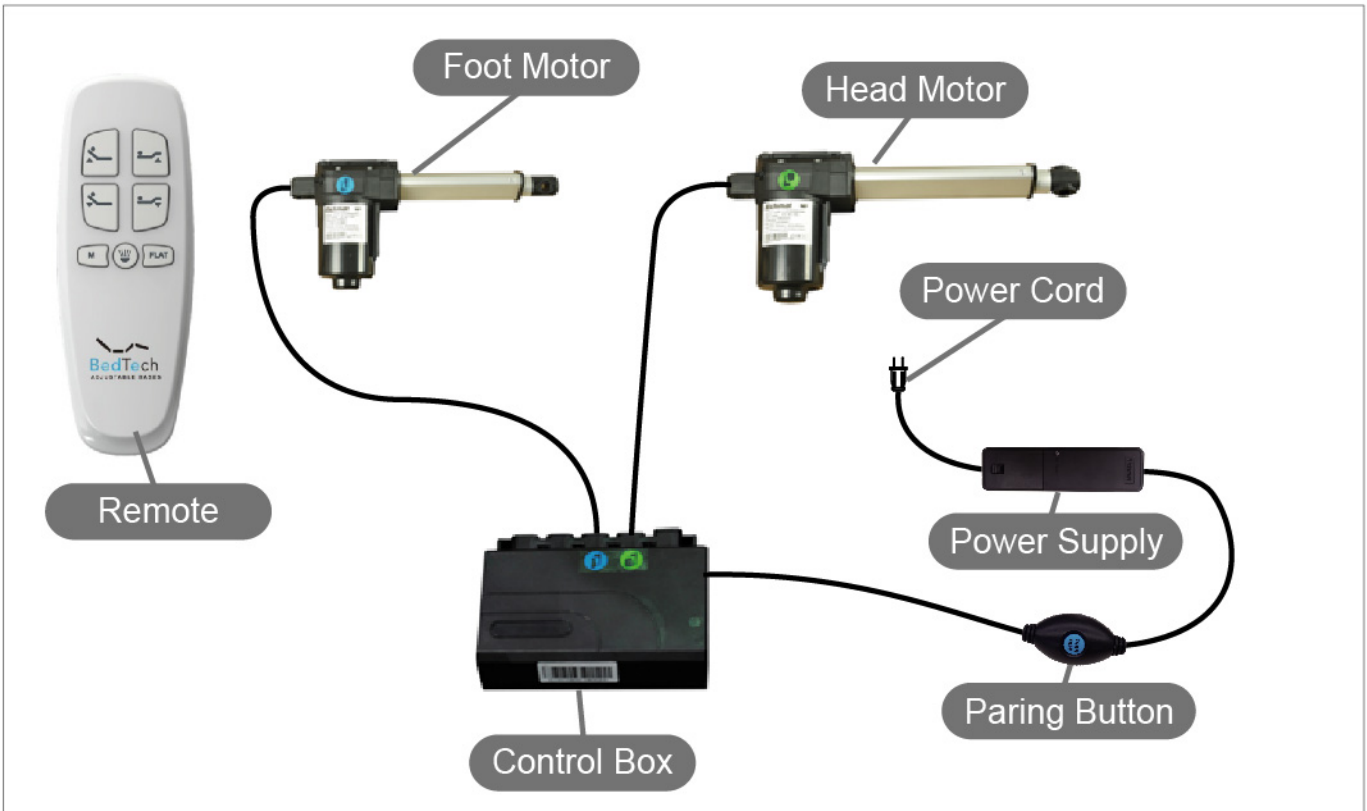

BT2500LP WIRELESS OVERVIEW

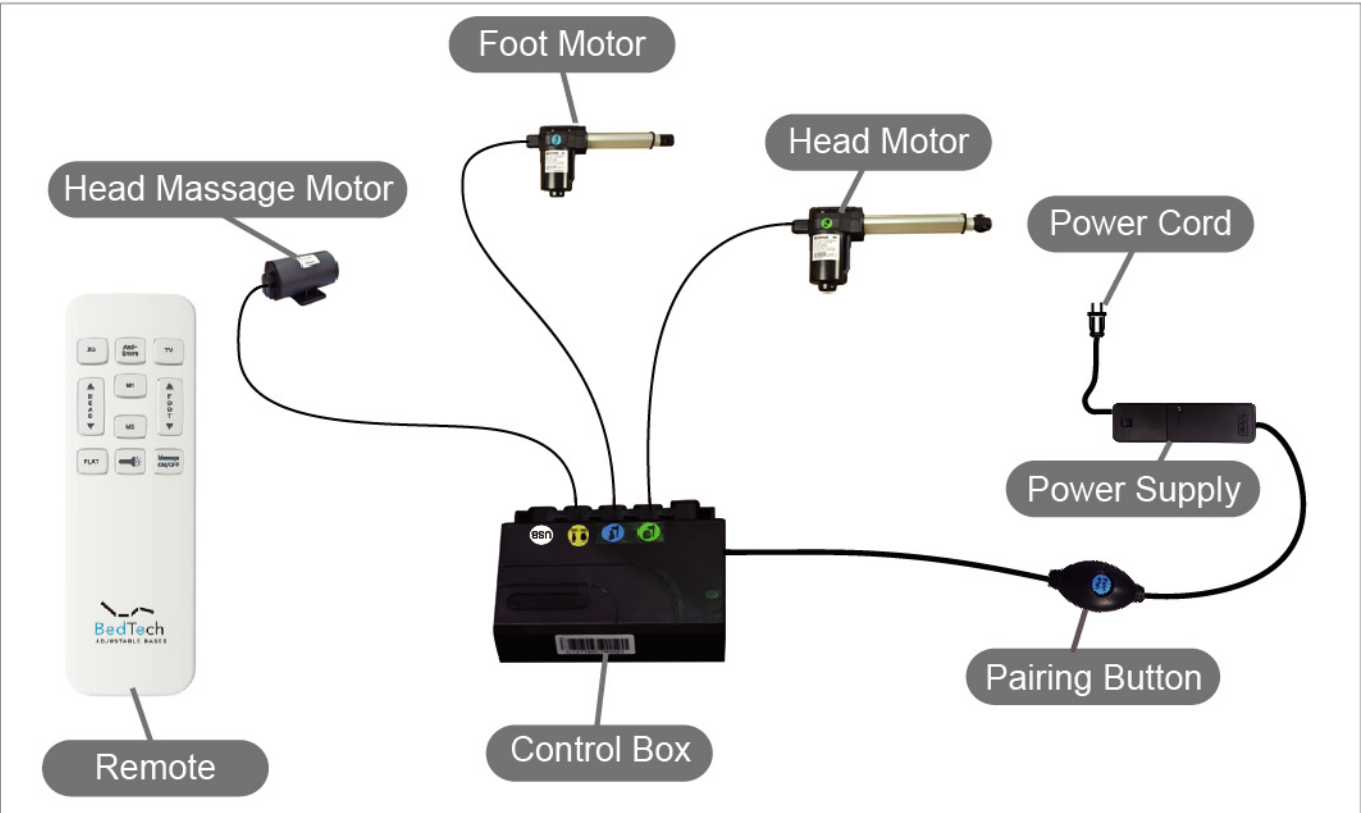

BT3000LP WIRELESS OVERVIEW

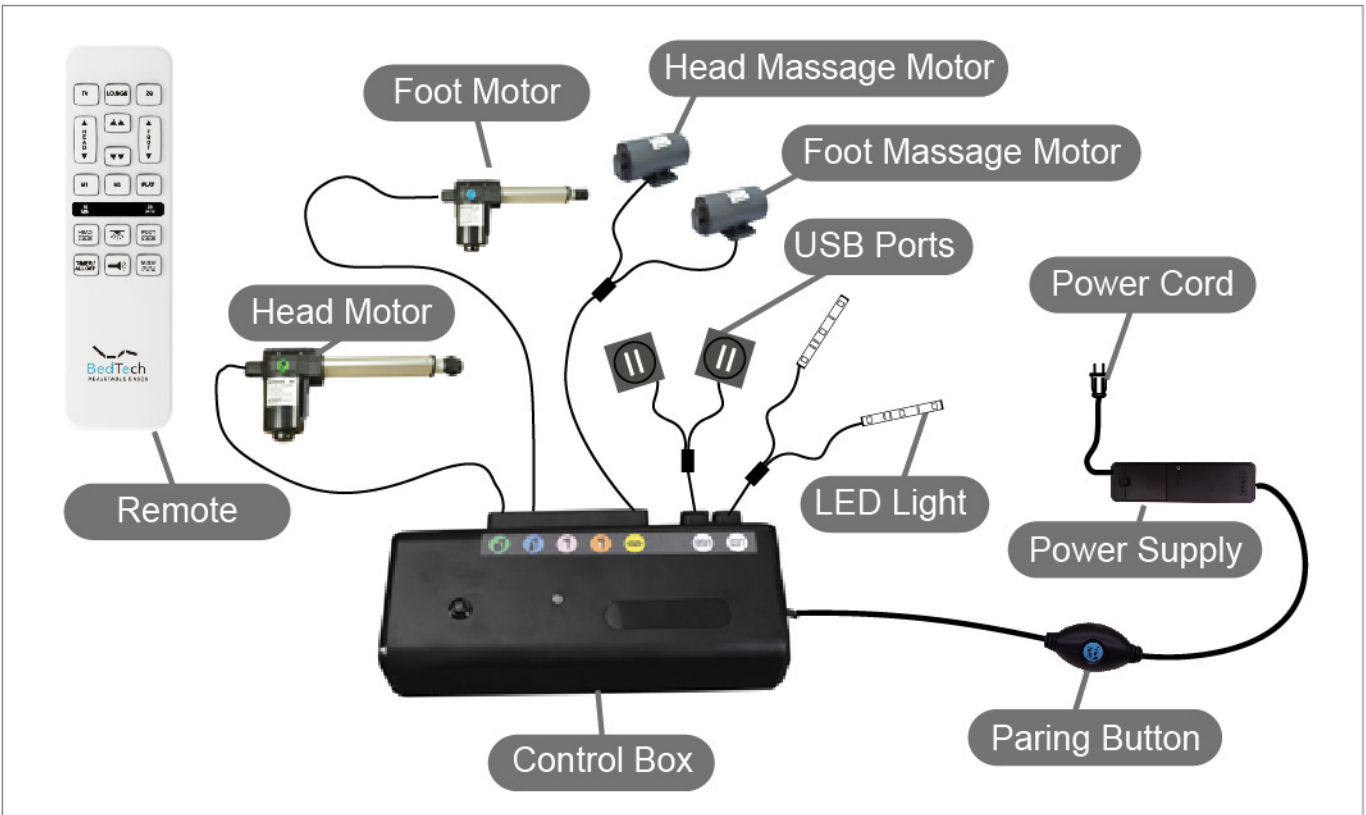

BT3500 WIRELESS OVERVIEW

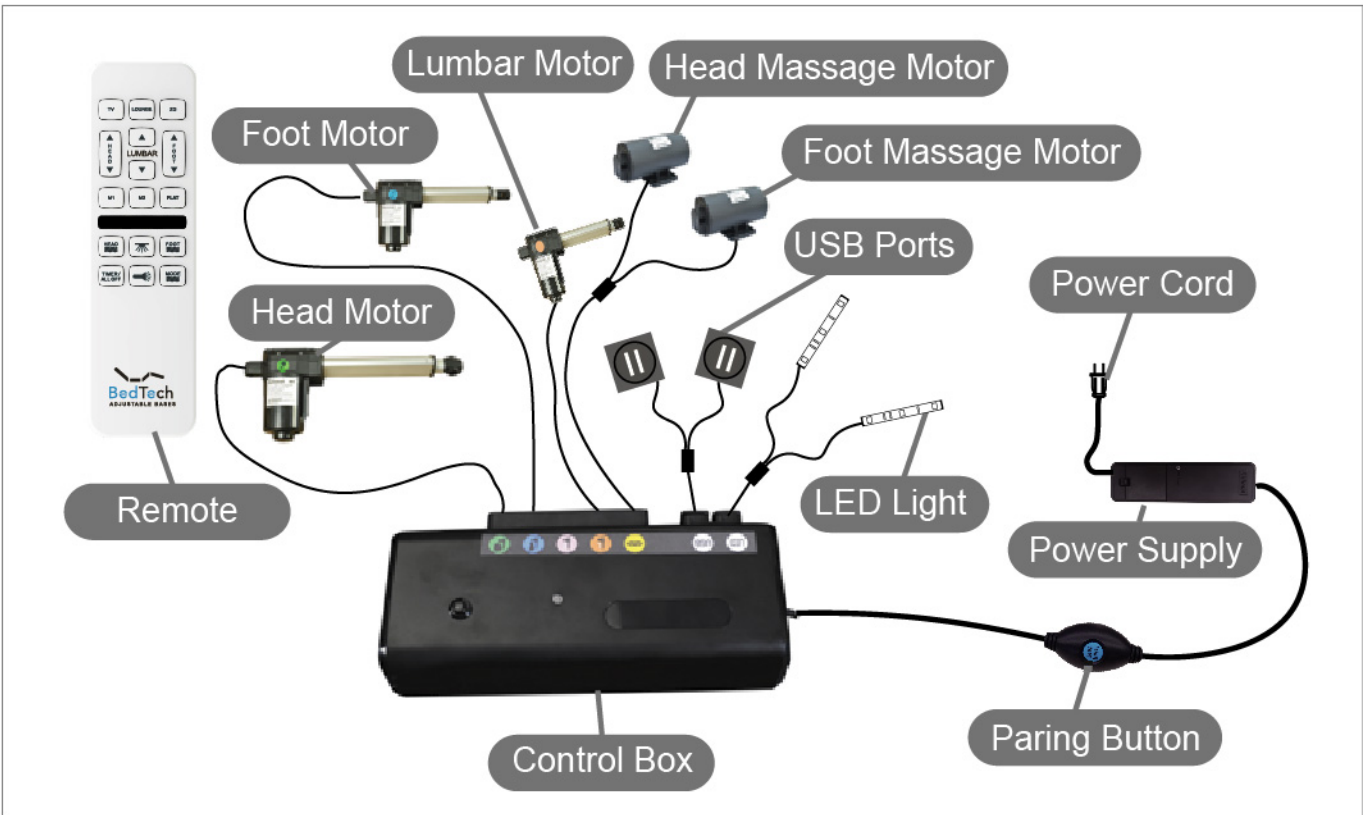
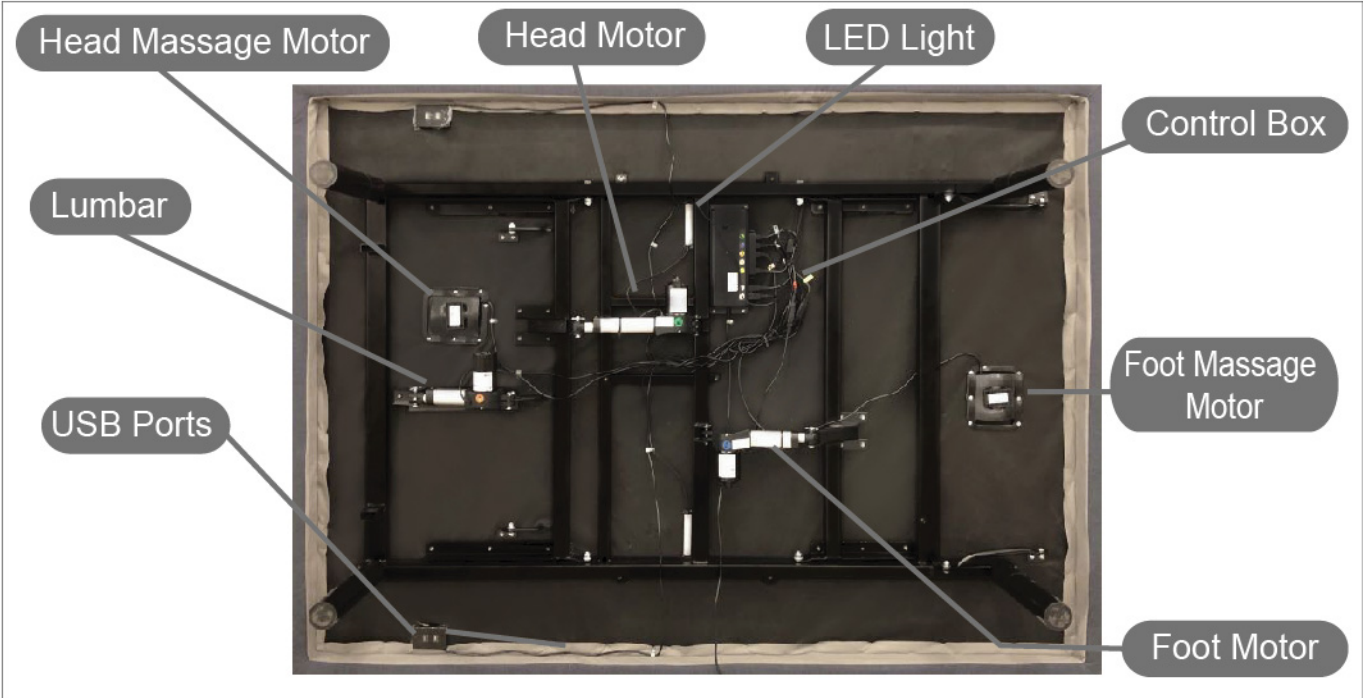

Two people are required to set up the foundation.

NOTE: To avoid damage to the foundation, always open the carton while the bed is in the flat position.

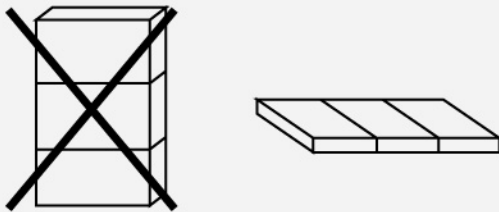

STEP 1

Place the foundation box in a desired location with the bottom of the box facing up.

Remove the binding straps and packing materials, making sure not to puncture the box with any sharp objects.



STEP 2

Remove the foundation from the box, keeping the bottom of the foundation facing upward for easier access to the bed's components.

STEP 3

To install the legs, thread the bolt of the leg to the nut on the foundation frame, and tighten by hand. **DO NOT OVERTIGHTEN. FOR SAFETY AND WARRANTY ALL 6 LEGS MUST BE INSTALLED BEFORE USE.**



STEP 4

Uncoil the input power cord (connected to the control box's power port) and plug it into the power supply.



STEP 5

Uncoil the power cord and connect it to the power supply.



STEP 6

Locate the power supply and install (2) 9-volt batteries (not included).



STEP 7

Carefully flip the foundation over onto its legs.

Important: Two people are required to move the foundation. **Do not drag across the floor. Do not rest frame on its side; excessive pressure may damage the legs.**

STEP 8

Ensure that batteries are correctly installed.



STEP 9

Locate the mattress retainer bar brackets.

Slide the left side of the mattress retainer bar into the bracket. Pull the retainer bar to the opposite bracket and secure the right side.



BT2000LP

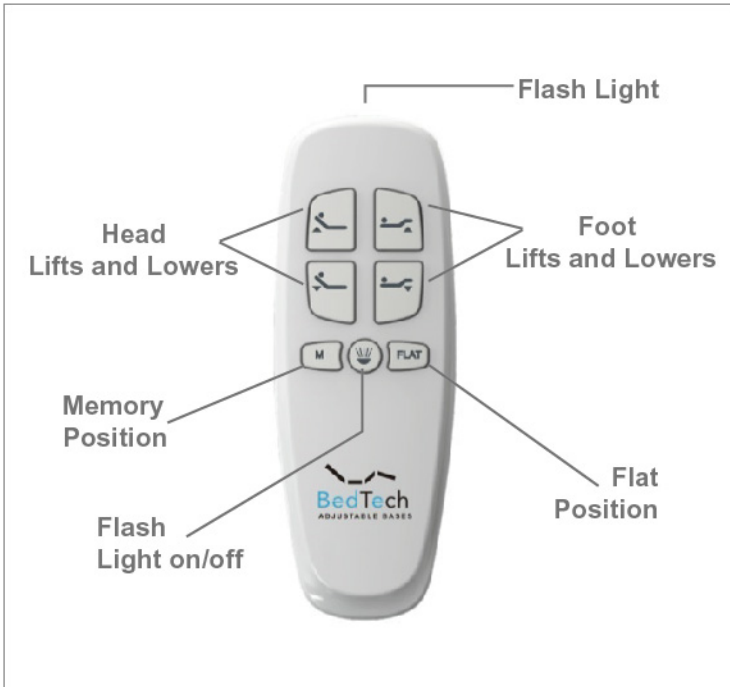

ADJUST

HEAD ▲▼ The **HEAD** ▲▼ arrows lift and lower the head section of the foundation.

FOOT ▲▼ The **FOOT** ▲▼ arrows lift and lower the foot section of the foundation.

 One touch flash light on/off.

ONE TOUCH BUTTON

FLAT One touch **FLAT** preset position.

M One touch memorized position.

BT2500LP

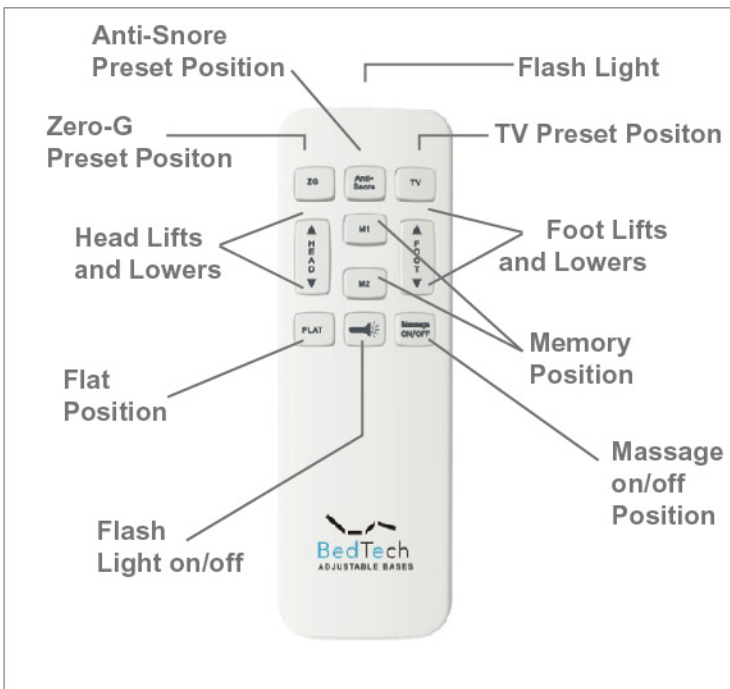

ADJUST

HEAD ▲▼ The **HEAD** ▲▼ arrows lift and lower the head section of the foundation.

FOOT ▲▼ The **FOOT** ▲▼ arrows lift and lower the foot section of the foundation.

 One touch flash light on/off.

ONE TOUCH BUTTON

FLAT One touch **FLAT** preset position.

M One touch memorized position.

BT3000 Remote Control Instructions



BT3000LP

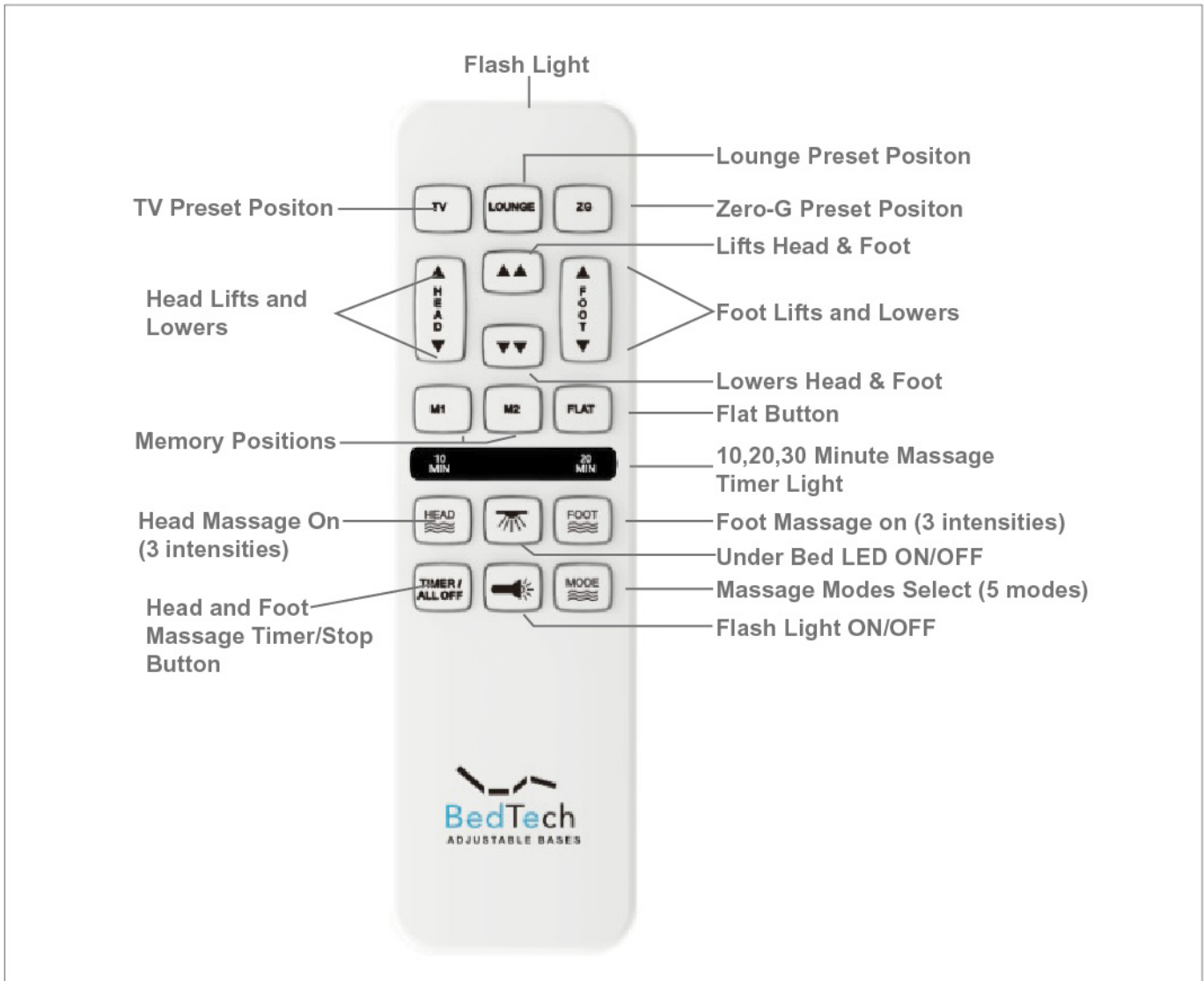

ADJUST

- ▲ The **HEAD ▲▼** arrows lift and lower the head section of the base.
- ▼
- ▲ The **FOOT ▲▼** arrows lift and lower the foot section of the base.
- ▼
- ▲▲ The double **▲▲** arrows lift and lower the head & foot section of the base.
- ▼▼
- 🔦 Press and hold the button, flash light will be on.

ONE TOUCH BUTTONS

- TV** One touch **TV** preset position.
- LOUNGE** One touch **LOUNGE** preset position.
- ZG** One touch **ZG** preset position.
- FLAT** One touch **FLAT** preset position.
- M1** One touch programmable preset position.
- M2**
- 🔦 One touch under bed LED light on/off.

MESSAGE FEATURE

- HEAD** The button will turn on the head massage. Cycle through 3 intensities.
- FOOT** The button will turn on the foot massage. Cycle through 3 intensities.
- MODE** The button will change the massage modes. Cycle through 5 intensities.
- TIMER / ALL OFF** The button will select a 10, 20 or 30 minute setting. Pressing a fourth time will turn off massage.
- 🔦 The light on the top of the remote indicates a 10,20 or 30(backlit of 10&20 MIN on) minute timer setting.

Customer Service: 1-888-236-3044

BT3500

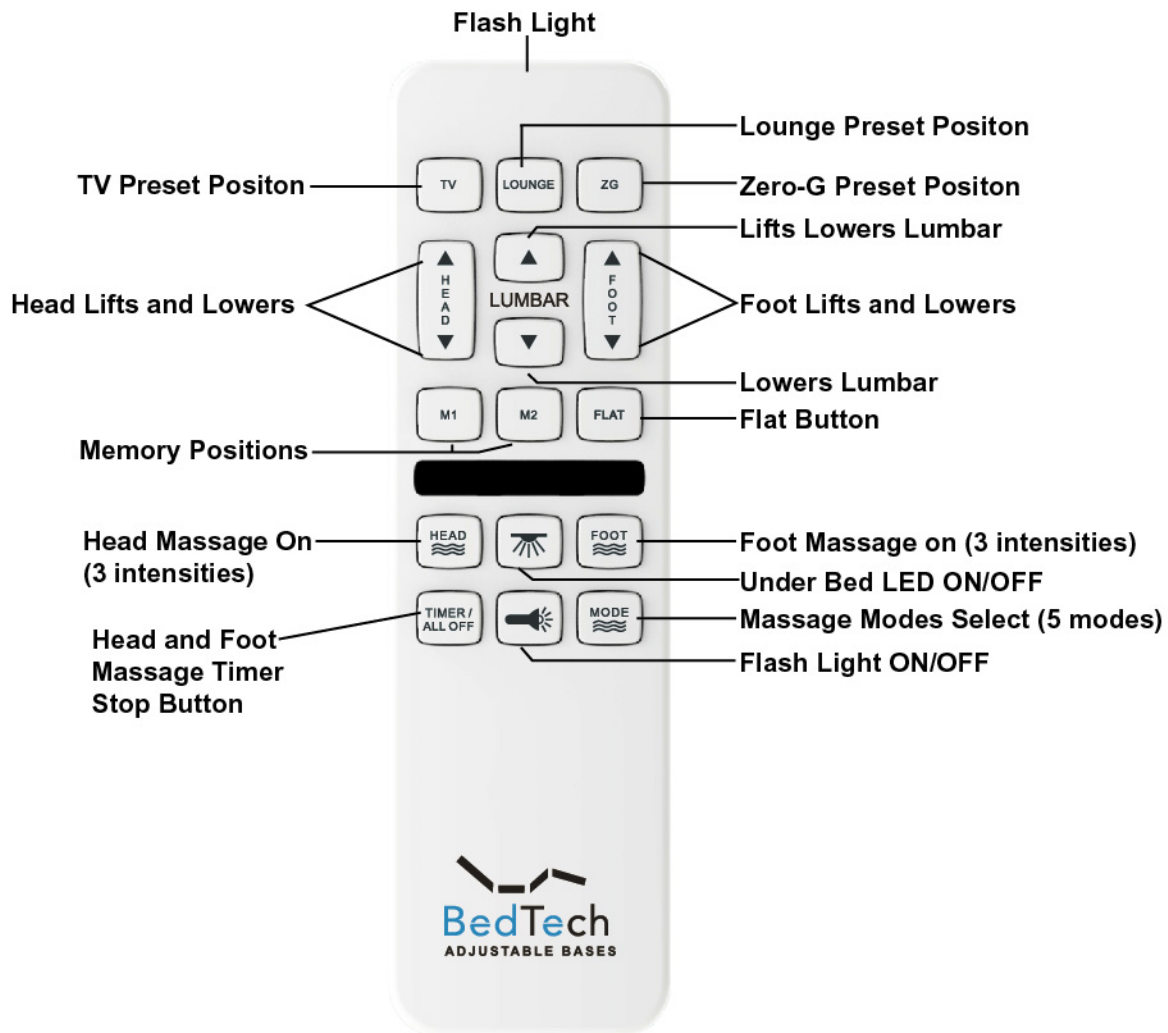





ADJUST

- ▲ The **HEAD ▲▼** arrows lift and lower the head section of the base.
- ▼ The **FOOT ▲▼** arrows lift and lower the foot section of the base.
- ▲▲ Lifts Lumbar
- ▼▼ Lowers Lumbar
- 🔦 Press and hold the button, flash light will be on.

ONE TOUCH BUTTONS

- TV One touch **TV** preset position.
- LOUNGE One touch **LOUNGE** preset position.
- ZG One touch **ZG** preset position.
- FLAT One touch **FLAT** preset position.
- M1 One touch programmable preset position.
- M2 One touch programmable preset position.
- 🔦 One touch under bed LED light on/off.

MASSAGE FEATURE

-  The button will turn on the head massage. Cycle through 3 intensities.
-  The button will turn on the foot massage. Cycle through 3 intensities.
-  The button will change the massage modes. Cycle through 5 intensities.
-  The button will select a 10, 20 or 30 minute setting. Pressing a fourth time will turn off massage.
-  The light on the top of the remote indicates a 10, 20 or 30 (backlit of 10&20 MIN on) minute timer setting.

BT3000LP

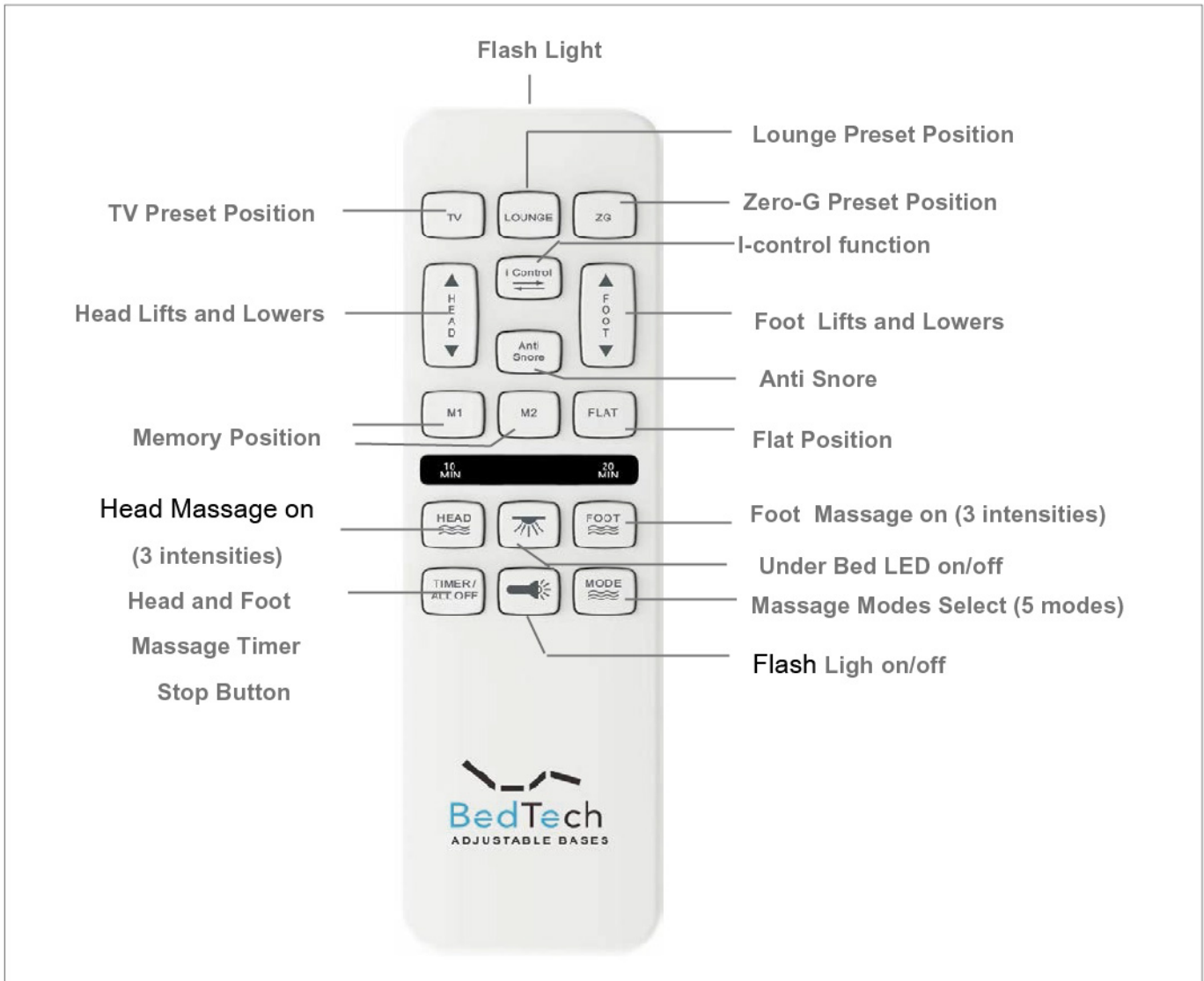

ADJUST

HEAD ▲▼ The **HEAD ▲▼** arrows lift and lower the head section of the base.

FOOT ▲▼ The **FOOT ▲▼** arrows lift and lower the foot section of the base.

i Control Control your partner's bed

Anti Snore After one touch i Control bottom, and one touch Anti Snore position for your partner's bed

LED Press and hold the button, flash light will be on.

ONE TOUCH BUTTONS

TV One touch **TV** preset position.

LOUNGE One touch **LOUNGE** preset position.

ZG One touch **ZG** preset position.

FLAT One touch **FLAT** preset position.

M1 One touch programmable preset position.
M2

LED One touch under bed LED light on/off.

MESSAGE FEATURE

HEAD The button will turn on the head massage. Cycle through 3 intensities.

FOOT The button will turn on the foot massage. Cycle through 3 intensities.

MODE The button will change the massage modes. Cycle through 5 intensities.

TIMER/ALL OFF The button will select a 10, 20 or 30 minute setting. Pressing a fourth time will turn off massage.

LED The light on the top of the remote indicates a 10,20 or 30(backlit of 10&20 MIN on) minute timer setting.

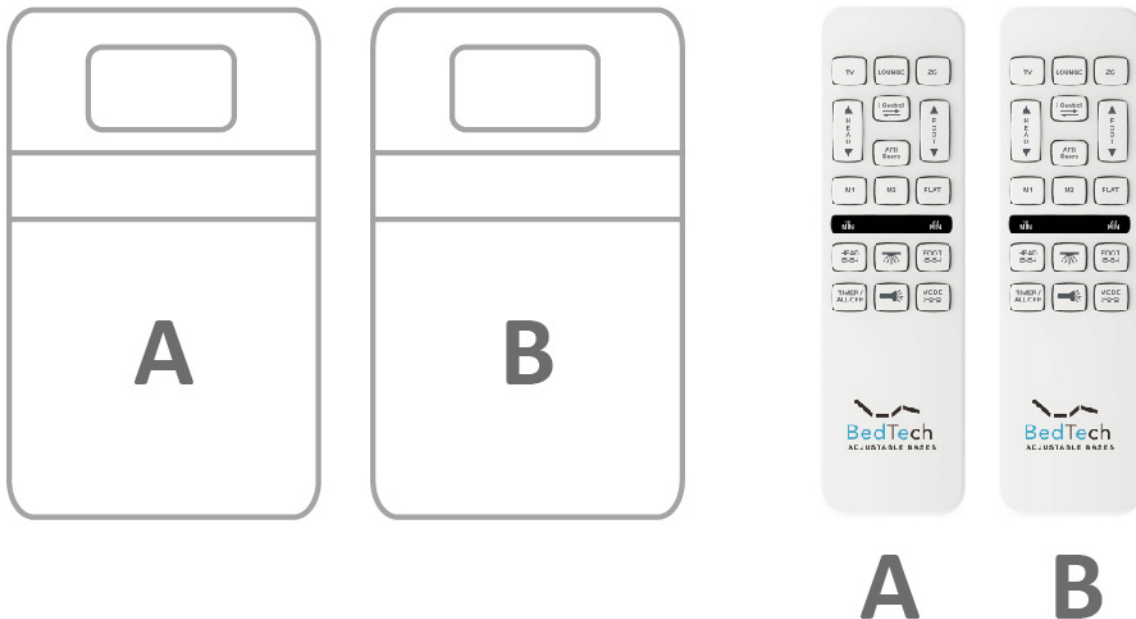

Remote A controls base A and base B

- Press remote A “i Control” button, the “10 MIN” light will be turned on, and press and hold head up and foot up button simultaneously, then press and hold the pairing button of base A control box for 3 seconds until you hear beeps sound, you can control base A.
- Press remote A “i Control” button one more time, the “20 MIN” light will be turned on, and press and hold head up and foot up button simultaneously, then press and hold the pairing button of base B control box for 3 seconds until you hear beeps sound, you can control your base B.
- Press remote A “i Control” button again, the “10 MIN” / “20 MIN” light will be turned on at the same time, you can control the base A and base B together.

Remote A and remote B control base A and base B

- Repeat all steps as above first, after that, press remote A and remote B “i Control” button, remote A and remote B “10 MIN” light will be turned on.
- Press head down and foot down button of remote B, the flashlight of remote B will be on at the same time, then press head up and foot up button of remote A. The remote A and remote B can control base A and base B.

All models Bluetooth Instructions



Step 1: Plug base into power source

Step 2: Turn Bluetooth on in cell phone

Step 3: Install the app

For APP System

1. Download Bed Tech APP
For IOS System

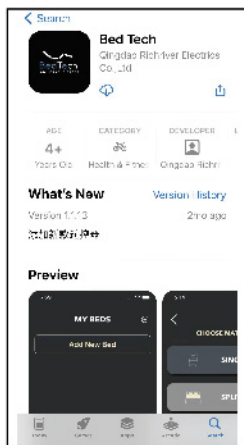

For Android System

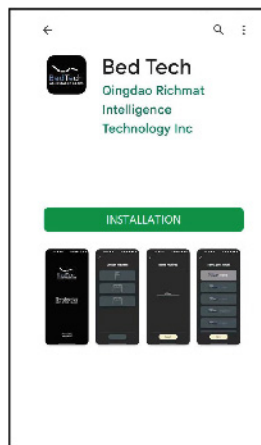

2. Open APP



3. Please press "Yes" to allow opening Bluetooth

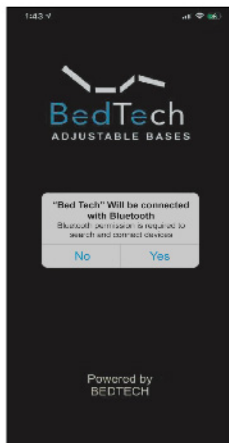

4. Touch the screen to enter interface



5. Choose your base model

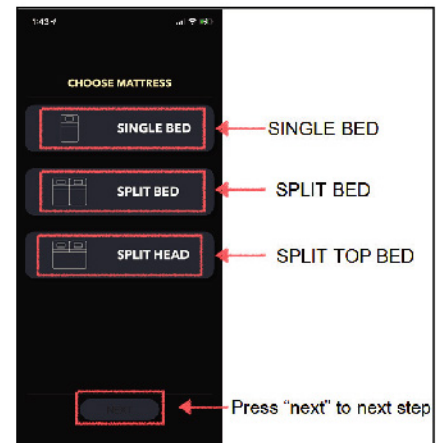

6. Given name for your base

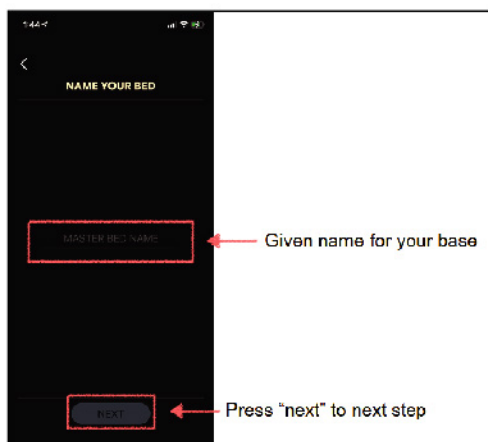

7. If you choose double base, you can give them each of name.

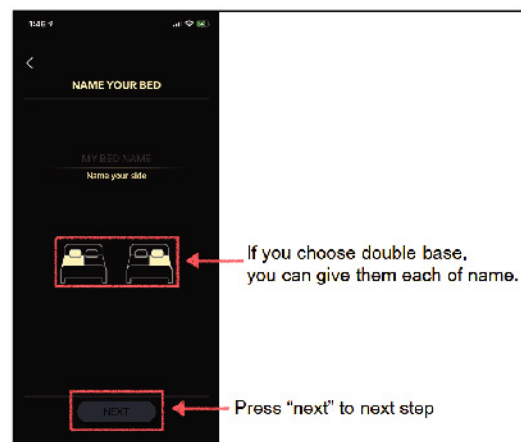

Customer Service: 1-888-236-3044

8. Choose your model of base

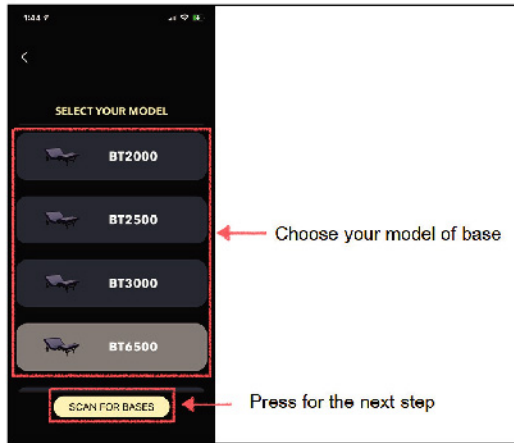

9. Choose your device and Testing

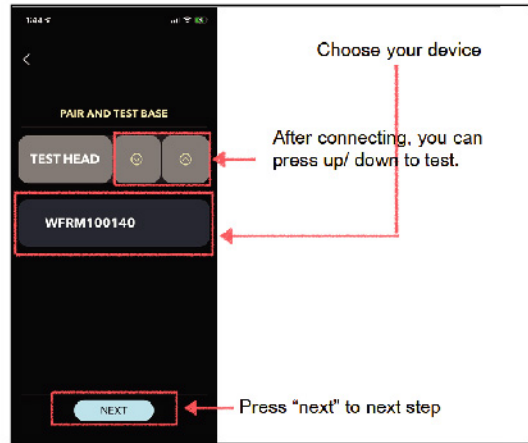

10. Open control center and select desired options.

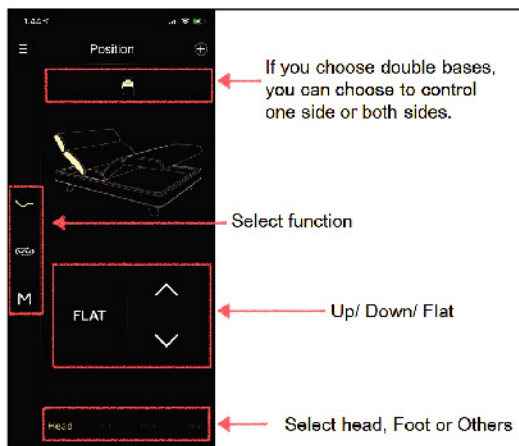

11. Massage controlled

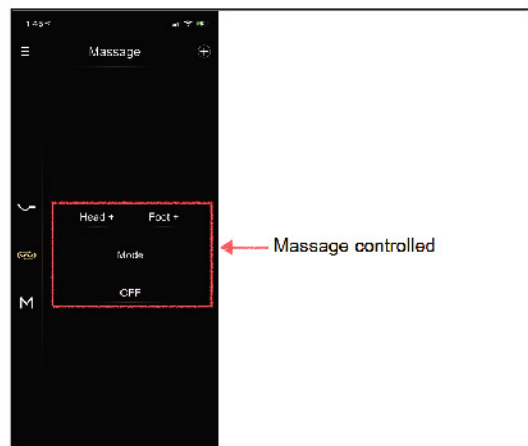

13. Adding another base

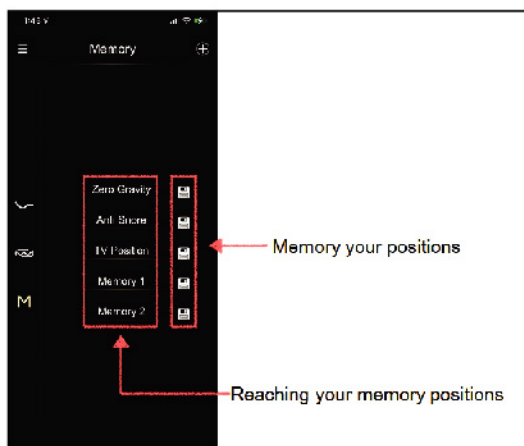

13. Adding another base

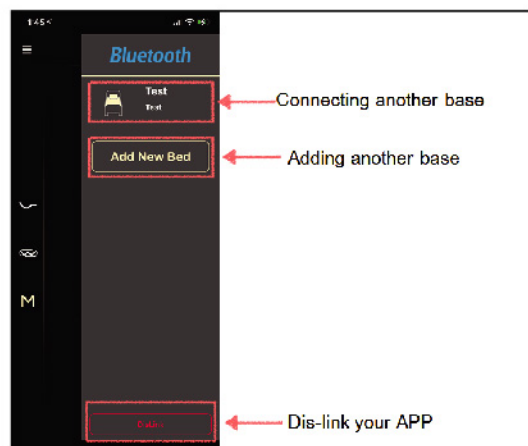

Setting Programmable Positions and Pairing Remote



SETTING PROGRAMMABLE POSITIONS



The wireless power bed has a programmable feature that allows you to save custom positions. Please read all the instructions below before setting your custom presets on the remote.

STEP 1

Adjust the head and foot to your desired position.



STEP 2

Press and hold the flat button  first, then press and hold memory button  for 5 seconds until the buttons' lights are flashing. The position is then saved.

STEP 3

To adjust the saved position, repeat steps 1 and 2 and the new position will be saved.

PAIRING REMOTE

The original remote that comes in the box is already paired to the foundation. No further action is required. In the event that the remote is not paired with the foundation, follow the steps below.

STEP 1

Make sure the batteries work fine. Replace them when needed.





STEP 2

Plug the power cord to the power source.



STEP 3

For BT2000LP/BT2500LP/BT3000LP

Press and hold  and  simultaneously, then press and hold the button on the cord of control box for 3 seconds until you hear 2 beeps sound, the remote is then paired.

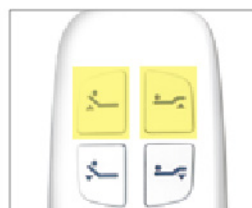

SYNCHRONIZING TWO BASES

If simultaneous operation of two foundations is desired, please read pairing remotes instructions on page 11.

STEP 1

Plug A and B bases to power source.

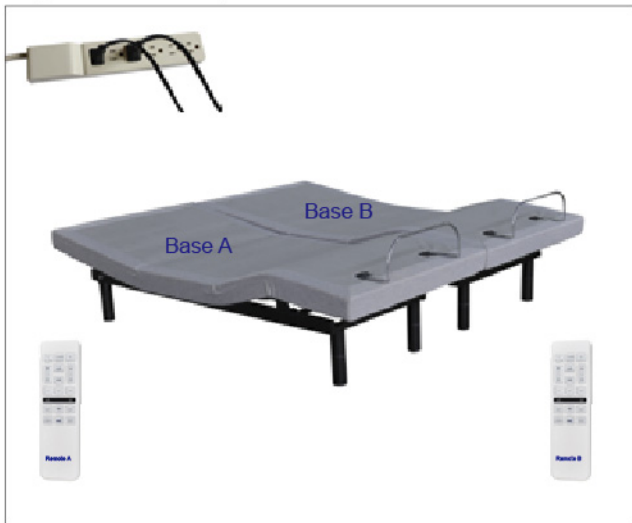

STEP 2

Make sure remote A was already paired to Base A and Remote B was paired to Base B. If not, please pairing them by following the pairing remote instructions on page 11.

STEP 3

Pair remote A to Base B, then base A and base B can be simultaneously operated by Remote A.

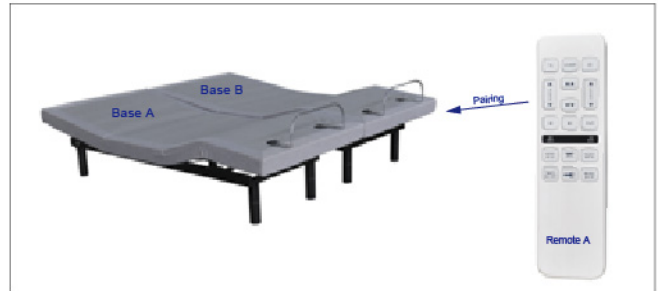

STEP 4

Set Remote B operate both bases too.

For BT2000LP, only one remote can control both bases.

Note: If you want to operate the beds separately, only need to use another remote to be paired to one of the beds.

For BT3000LP/BT3500, please follow the instructions below.

Press and hold head down and foot down buttons on remote B, The flash light will be on for 10 seconds. Meanwhile press and hold head up and foot up buttons on Remote A, the learning process is successful when the flashlight on remote B starts to flash. Now both remotes will be able to operate both beds simultaneously.

Note: If you want to operate the beds separately, for BT3000LP, press and hold  and  on remote B.

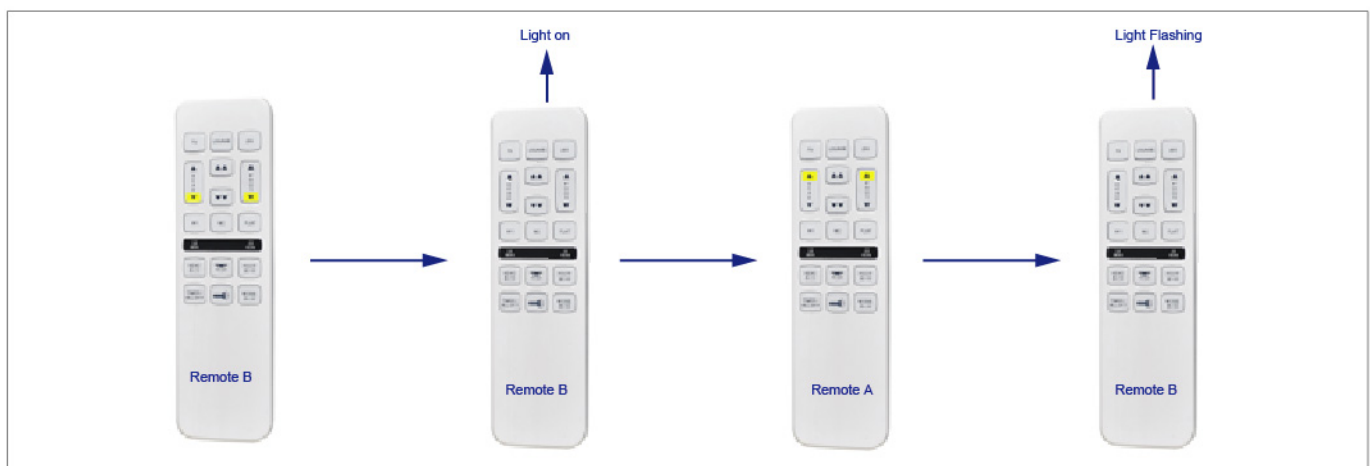





Headboard Bracket Installation Guide



Headboard brackets are an optional accessory and are not included.

A 1/2" (13 mm) socket and 1/2" (13 mm) crescent wrench are necessary to complete installation.

HEADBOARD BRACKET COMPONENTS

(2) Headboard Brackets	(2) T-Brackets	(4) Short Bolts	(12) Nuts	(8) Long Bolts
				

STEP 1

The headboard bracket will have 2 long slots to accommodate any frame type. Align the appropriate slots on the bracket with the holes on the bed. Use long bolts and nuts to secure the bracket. Make sure the bolts are tight.



STEP 2

To put the T-Bracket and Headboard Bracket together, you will need (2) short bolts and (2) nuts. Slip the bolts through the holes from T-Bracket to Headboard Bracket with the head of bolt facing outward. Use 1/2" (13mm) socket and 1/2" (13mm) wrench to tighten the bolts.



STEP 3

You may now connect your headboard to the attachment plates using the remaining short bolts and nuts to secure it to the brackets. The heads of the bolts will face outward. Use a 1/2" (13 mm) socket and 1/2" (13 mm) wrench to tighten the bolts.

****Every headboard is different and may require a different set of bolts to connect to your set up.****

In the event that the power foundation fails to operate, assess the symptoms and possible solutions provided in the chart below.

SYMPTOMS	SOLUTIONS
Remote control illuminates and appears to be operable, but will not activate bed.	Verify that the power cord is plugged into a working, grounded electrical outlet. Test the outlet by plugging in another working appliance.
No features of the power foundation will activate.	<p>Program the remote control (see the Setting Programmable Positions and Pairing Remote section of this manual for programming procedures).</p> <p>Unplug the power cord, wait 30 seconds and plug back to reset electronic components.</p> <p>The surge protection device or the electrical outlet may be defective. Test the outlet by plugging in another working appliance.</p> <p>Verify that the connector on the wired remote control is securely attached to the control box.</p>
Wireless remote will not illuminate.	Replace the batteries in the wireless remote.
Head or foot section will elevate, but will not return to the horizontal (flat) position.	<p>Bed mechanism may be obstructed. Elevate bed and check for obstruction. Remove obstruction.</p> <p>Head section may be too close to the wall.</p> <p>Headboard may be too close to the edge of the mattress. Verify that there is enough distance between the headboard brackets and mattress. Adjust if required.</p>

In the event that the power foundation fails to operate, assess the symptoms and possible solutions provided in the chart below.

SYMPTOMS	SOLUTIONS
<p>Head & Foot lift function has minor interference during operation.</p>	<p>Check batteries in wireless remote control, replace with two (2) new AAA batteries if necessary.</p> <p>Make sure that you are following the duty cycle of the motors (do not operate more than two minutes over a 20-minute period, or approximately 10% duty cycle).</p> <p>Press the lift buttons squarely and accurately.</p> <p>Wireless remote control may be experiencing common Radio Frequency Interference from other radio transmitting devices. Wait several seconds, and then try pressing appropriate button again, See FCC Compliance Statement on page 1 of this guide.</p>
<p>Excessive massage motor noise.</p>	<p>If the bed is located on hard surface flooring, place carpet pieces or rubber pieces (not included) under each leg.</p> <p>Using the wireless remote control, elevate the head, foot or neck section a short distance to realign the lift/lower mechanisms with the bed support platform.</p> <p>Verify that your Bed Tech Power Foundation is not positioned against a wall, nightstand, or other object that may cause the vibration or noise.</p> <p>If the Bed Tech Power Foundation is installed over a bed frame, verify that the massage motors are not causing the bed frame (or bed frame components) to vibrate.</p> <p>Verify that the headboard attachment hardware is properly tightened (if used).</p>
<p>A clicking noise is heard under the bed when raising or lowering.</p>	<p>This is normal. The lift motor relays “click” when they are engaged. No action is required.</p>
<p>Massage motor overheats or stops.</p>	<p>If the vibration motor overheats, the thermal protection will turn the motor off. Wait 30 minutes, turn the massage back on. If it does not come on, turn it off and report the situation to customer service.</p>